



i400s

User Manual



Thank you very much for buying the Ferguson i400s. In order to let you freely operate the product and fully enjoy the overbalancing happiness it brings you, we have introduced each function of the player in detail in this user manual. Please carefully read this user manual before use and keep for future reference.

Table of Contents

1. Network Requirement	5
2. Safety Precaution	5
3. Appearance and Key Description	8
4. Getting Started	9
5. Ferguson i400s Functions	11
5.1 Main Menu	11
5.2 System Settings	12
5.3 Internet Radio	17
5.4 Spotify Connect	20
5.5 Music Player	21
5.6 DMR (DLNA streaming)	23
5.7 DAB	25
5.8 FM	27
5.9 Bluetooth	29
5.10 CD	29
5.11 AUX IN	31
5.12 Sleep	32
5.13 Alarm	32
5.14 Extra Features	33
6. Troubleshooting	38
7. Specifications	39

MARKINGS AND SIGNS APPLIED TO THE DEVICE



Risk of electric shock - do not open.

This notice warns the user not to open the receiver housing. The housing may be opened solely by authorized service technicians.



When this crossed-out wheeled bin symbol is attached to a product it means that the product is covered by the European Directive 2002/96/EC. Please inform yourself about the local separate collection system for electrical and electronic products.

Please act according to your local rules and do not dispose of your old products with your normal household waste. Correct disposal of your old product helps to prevent potential negative consequences for the environment and human health.



Your product contains batteries covered by the European Directive 2006/66/EC, which cannot be disposed with normal household waste. Please inform yourself about the local rules on separate collection of batteries because correct disposal helps to prevent negative consequences for the environmental and human health.



The logo informs that the receiver conforms to the terms and conditions of Directive 2004/108/EC concerning observance by Member States of provisions regulating electromagnetic compatibility, and to the terms and conditions of Directives 2006/95/EC concerning observance by Member States of provisions regulating low voltage electricity and safety with relation to the handling and operation of electrical equipment.



Hereby Ferguson Sp. z o.o., declares that the device is in compliance with the essential requirements and other relevant provisions of Directive 2014/53/UE. You can find the Declaration of Conformity on www.deklaracje.ferguson.pl

This product has been designed, tested and manufactured according the European R&TTE directive 2014/53/UE.



Double insulation logo.

This logo informs that the devices an electrically safe device, provided that it is used in accordance with the recommendations set forward in the chapter concerning safety.

When this logo is attached to a product, it means that a financial contribution has been paid to the associate national recovery and recycling system.

1. Network Requirement

- A broadband connection in combination with a wired/wireless access point, router or similar network device.
- The network device needs to support Ethernet (LAN) wired connection or WiFi (802.11 b/g/n) wireless connection.
- PC, tablet or smartphone with network connected. This network has to be the same one as the Ferguson i400s equipped with.

2. Safety Precaution

General

- Do not drop the Ferguson i400s and do not expose it to liquid, moisture or humidity. These might lead to damage to the device.
- If the Ferguson i400s is moved from a cold environment into a warmer one, do let it adapt to the new temperature before operate the device. Otherwise, it might lead to condensation and cause malfunctions in the device.
- Do not use the Ferguson i400s in the dust environment as dust can damage the interior electronic components and lead to malfunctions in the device.
- Protect the Ferguson i400s from strong vibrations and place it on stable surfaces.
- Do not attempt to disassembly the Ferguson i400s.
- If the Ferguson i400s is not using for a long period of time, disconnect it from the power supply by unplugging the power plug. This is to avoid the risk of fire.

Power adapter

- Only use the power adaptor delivered with the Ferguson i400s.



- The socket outlet should be installed near the Ferguson i400s and should be easily accessible.
- Never touch the power plug with wet hands and never pull on the power cable when pulling the plug out of the power socket.
- Make sure the electrical voltage specified on the Ferguson i400s and its power plug is corresponding to the voltage of the power socket. Incorrect voltage will destroy the device.



Compact discs

- Use only Digital Audio CDs which have the  symbol.
- DO NOT USE THESE TYPES OF DISC:
 - Mini (8cm) CDs. Use only full-size 12cm discs. Mini CDs will jam the feed mechanism.
 - Discs which do not have a complete metallic reflection layer. Discs with a large transparent section will not be detected and may fail to play or eject.
 - Disc which are extra thin or flexible. Such discs may fail to feed in or out correctly and may jam the CD mechanism.
- Never write on a CD or attach any sticker to the CD. Always hold the CD at the edge and store it in its box after use with the label facing up.
- To remove dust and dirt, breathe on the CD and wipe it with a soft, lint free cloth in a straight line from the centre towards the edge.
- Cleaning agents may damage the CD.
- Do not expose the CD to rain, moisture, sand or to excessive heat. (e.g. from heating equipment or in motor cars parked in the sun).

Risks associated with high volumes

- While listening the Ferguson i400s with headphones, always reduce the volume before put on the headphones. After the headphones are positioned properly, increase the volume to the desired level.



Maintenance / cleaning

- Always power off the Ferguson i400s when cleaning it.
- Never use any harsh or strong solvents to clean the Ferguson i400s since these may damage the surface of the device. Dry, soft cloth is appropriate, however, if the Ferguson i400s is extremely dirty, it may be wiped off with a slightly moist cloth. Make sure the device is dried off after cleaning.
- When you are necessary to ship the Ferguson i400s, store it in its original package. Save the package for this purpose.

Disposal

- If have to dispose the device in the future, note that it should not be disposed with household waste. Bring it to a reception point for the recycling of electrical devices. Consult your local authority or retailer for recycling advice.



3. Appearance and Key Descriptions

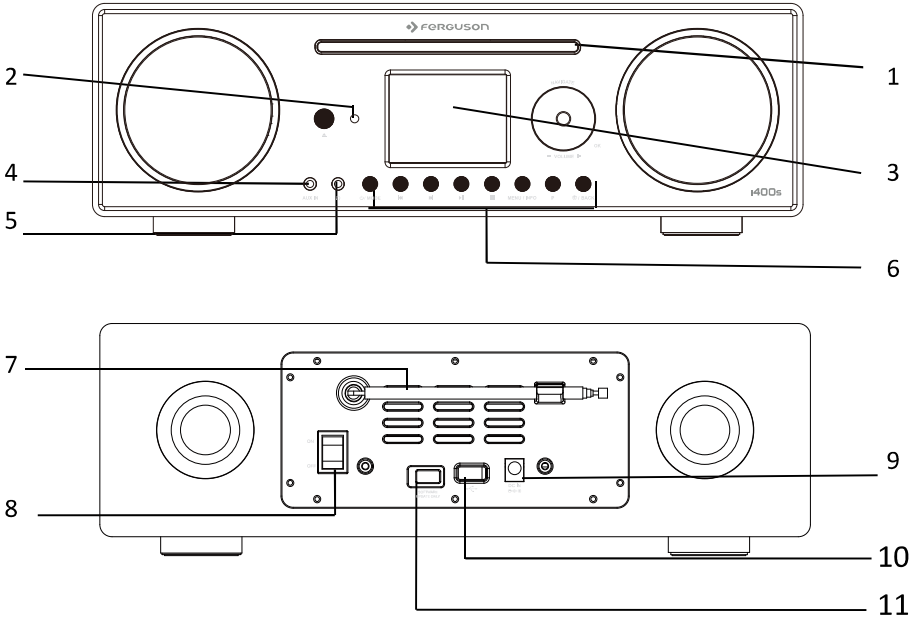

No.	Description	Functions
1	CD	Play CD
2	IR receiver	Receive infrared signal from remote
3	2.8" TFT Screen	Display
4	AUX	3.5mm jack for AUX IN
5	Earphone jack	3.5mm jack for headphone or earphone
6	Buttons and Reel	Basic control of operation
7	DAB/FM antenna	Strengthen the DAB/FM receiver
8	Power switch	Power on/off the internet radio
9	DC IN	Power supply
10	USB port	Plug the USB drive or MP3 player for music playback
11	"Software update only" port	Update the software

Remote Controller

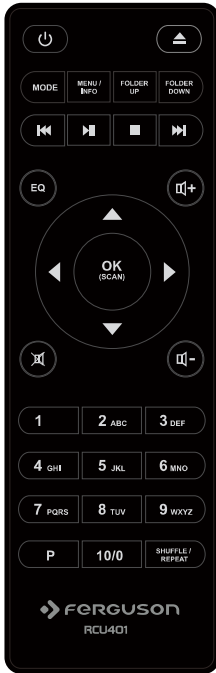

Use your thumb to press the lid of the battery compartment and pull it out. Install 2 x AAA type 1.5V battery into the battery compartment, taking care to insert it with the positive (+) side up.



Risk of explosion if battery is replaced by an incorrect type. Dispose of used batteries according to the instructions.

4. Getting Started

The items enclosed in the packaging box are as follows:

- Ferguson i400s unit
- Power adaptor
- Audio cable with 3.5mm jack at both ends
- User manual

Connect the power adaptor to the back of Ferguson i400s and plug it into power socket.

Get the network environment ready

- *For wireless WiFi*
Make sure you have setup the wireless network and you have the WEP, WPA or WPA2 security password to activate the connection.
You may also use the WPS (WiFi Protected Setup) function for easy pairing



between the network device and Ferguson i400s. Check if the light indicators on the network device are in appropriate status.

Switch it on from Ferguson i400s.





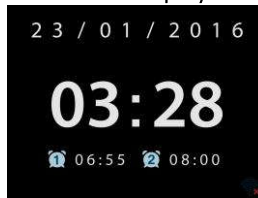

At the first time operation, system asks if you want to start the Setup Wizard. Select **YES** to continue the setup. Details of the Setup Wizard can be referred to Section 5.2.1 below. After choosing **NO**, the next screen asks if you would like to run the wizard next time Ferguson i400s is started.

Ferguson i400s will automatically connect to the network that was set before when power on to Internet Radio again. In case you desire to change the network, enter **System Setting** to configure the corresponding connection. Refer to Section 5.2.1 and 5.2.3.

Press and hold  /MODE or press  on the remote control to enter standby mode. The time, date and any active alarm times display on the screen.



Rotate the reel or Press  /  on the remote control to adjust the volume. Rotate the volume reel or press  until volume level becomes 0, or direct press  to mute the sound.

Music Sharing from PC

- To share the music files from PC, the following steps are done on the PC:

- Connect the PC to the network.
- Ensure Ferguson i400s is powered on and connected to the same network.
- Open the UPnP platform **Windows Media Player** (11 or later).
Alternatively, other platforms or server such as **Windows Media Connection** may be used.



- Allow to share your media to **Ferguson i400s** , which is the device name for music streaming.

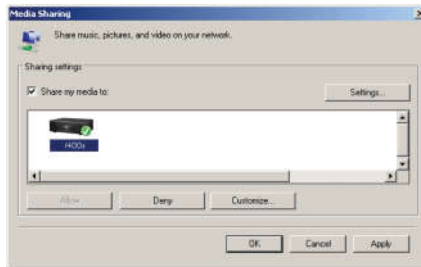

- Add the audio files and folders you want to share with Ferguson i400s to the media library.

5. Ferguson i400s Functions

5.1 Main Menu

Under the main menu, you can select the following modes: Internet Radio, Spotify Connect, Media Player, DAB, FM, Bluetooth, CD, AUX IN, Sleep and Alarm.

Alternatively, press **MODE** to enter main page, move to the mode by rotating the reel or press ◀ or ▶ on the remote control.



5.2 System Settings

5.2.1 Setup Wizard



- **Time/date**
Display format
Select 12 or 24 as the time format.

Auto-update

The time and date can be updated manually or automatically from DAB, FM or network.

Auto-update works with data sent over DAB, FM or the Internet. The clock is only updated when in a corresponding mode, so it is best to select a mode you use regularly.

DAB and FM use time signals broadcast with radio transmissions. Network uses a time signal sent from the Internet radio portal when in any network-connected mode.

Time zone, daylight

Set your time zone. If your country uses daylight saving and it is in effect, turn on the Daylight savings option.

Manual update

If you set No update, the wizard prompts you to set the time and date manually. The date and time are displayed as dd-mm-yyyy and hh:mm.

The active value appears as flashing. Adjust each value with the navigate reel or ◀ / ▶ on the remote control. Once the value is set, press the reel or OK (SCAN) on the remote control to continue setting with next value.

- Network

Wlan region

Select the Wlan region to obtain the optimal Wlan connectivity: Canada, Spain, France, Japan, Singapore, Australia, and Republic of Korea.

Scanning for the network

Ferguson i400s is compatible with all common network protocols and encryption methods. It searches for the available networks and list them out for you choose.

There will be hints for the type of network – if you plug the LAN cable, it will show one network of **[wired]**; if your network device supports WPS function, it will be **[WPS]** before the SSID (the name of network device). Select the one you want to connect.

For the wireless connection, you will be asked for input encryption in the next step.

Standard encrypted network

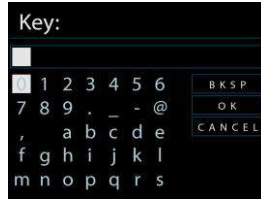

To enter the network’s key, use the navigate reel or direction keys on the remote control to move the cursor through the characters and press the reel or OK (SCAN) on the remote control to confirm. As each character is selected, the key is built up near the top of the display.

There are three options accessible by tuning the navigate reel back before the first characters – Backspace, OK and Cancel.

WPS encrypted network

WPS encrypted networks are identified by **WPS** at the start of the network name when the Ferguson i400s searches the available AP. Use one of the following methods of connection:

- Push button

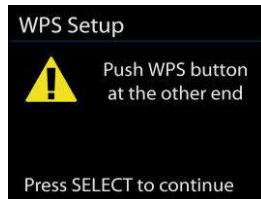

Ferguson i400s prompts you to press the connect button on the router. It then scans for a ready Push Button Connect network and connects.

- Pin

Ferguson i400s generates an 8-digit code number which you enter into the wireless router, access point, or an external registrar.

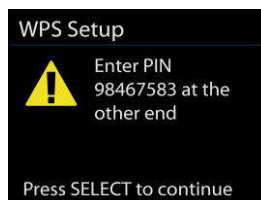

- Skip WPS

Enter key as for a standard encrypted network.

For more information on setting up a WPS encrypted network, see your WPS router's instructions.

- Completion

Ferguson i400s attempts to connect to the selected network.

It will show connected if the setup is successful. If connecting fails, Ferguson i400s returns to a previous screen to try again.



Press the reel or OK (SCAN) on the remote control to quit the setup wizard.

5.2.2 Equaliser



Several preset EQ modes are available: Normal, Flat, Jazz, Rock, Movie, Classic, Pop and News.

Also a user-defined setting is available; create your own EQ with custom bass, treble settings.

5.2.3 Network

- Network wizard

Enter to search AP SSID, then input the WEP / WPA key or choose Push Button/Pin/Skip WPS to connect to the wireless network.

- PBC Wlan setup
Push Button Configuration, it is to connect the AP that supports WPS (Wi-Fi Protected Setup).
- View settings
View the information of current connected network: Active connection, MAC address, Wlan region, DHCP, SSID, IP address, Subnet mask, Gateway address, Primary DNS and Secondary DNS.
- Wlan region
Select the Wlan region to obtain the optimal Wlan connectivity: Canada, Spain, France, Japan, Singapore, Australia, and Republic of Korea.
- Manual settings
Choose wired or wireless network connection and enable or disable DHCP (Dynamic Host Configuration Protocol).
- Network profile
Ferguson i400s remembers the last four wireless networks it has connected to, and automatically tries to connect to whichever one of them it can find.
From here you can see the list of registered networks. You can delete unwanted networks by turning and pressing the reel or **ENTER** on the remote control then choosing YES to confirm delete.
- Keep network connected

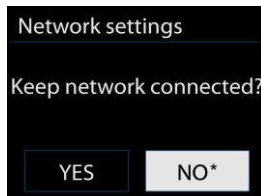

If you choose to keep network connected, the WiFi will not disconnect even you are in standby mode. Otherwise, the connection will only available. This option allows Ferguson i400s to be ready for DLNA streaming in any operating modes. Details for DLNA streaming, refer to Section 5.6.

5.2.4 Time/Date

Set the time manually or auto update, time format, time zone and daylight.

5.2.5 Language

The default language is English. Change it as your preference.

5.2.6 Factory reset

A factory reset resets all user settings to default values, so that time and date, network configuration and presets are lost. However, the Ferguson i400s's current software version is maintained, as is registration with the Internet radio portal. Internet radio favourites therefore remain unless you re-register your Ferguson i400s with another account on the portal website.

5.2.7 Software update

From time to time, software upgrades may be created with bug fixes and/or additional features. You can either check manually or set Ferguson i400s to check periodically automatically (this is the default). If newer available software is detected, you will be asked if you want to go ahead with an update. If you agree, the new software is then downloaded and installed. After a software upgrade, all user settings are maintained.

NOTE: Before starting a software upgrade, ensure that Ferguson i400s is plugged into a stable main power connection. Disconnecting power during an upgrade may permanently damage the unit.

5.2.8 Info

View the firmware version and the radio ID.

5.2.9 Backlight

You may change the backlight of each environment (power on or standby) to High, Medium or Low. And adjust the timeout duration which the radio turns to standby backlight level when it has not been controlled.

5.3 Internet Radio

Ferguson i400s can play thousands of radio stations and podcasts from around the world though a broadband Internet connection.

When you select Internet radio, Ferguson i400s directly contacts the Frontier Silicon Internet radio portal (which is supported by v-tuner) to get a list of stations.

The portal also enables multiple lists of favourite stations that you can personalize.

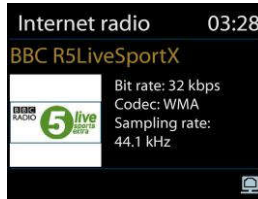

If you are already listening to an Internet radio station, you can press **BACK** or  on the remote control to quickly return to the last visited branch of the menu tree, rather than press and hold **MENU / INFO** to go to the first menu of Internet radio mode.

Press  to pause playing. Press again to play the station.

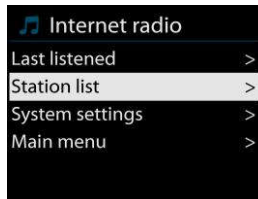

5.3.1 Last listened

When Internet radio mode restarts, the last-listened station is selected. To select another recently used station, enter here to select the listed station. Most recent stations appear at the top of the list.

5.3.2 Station list

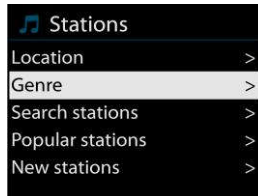

Browse Internet broadcasts that organized into different categories, Location, Genre, Popular and New. You can also find the station with Search by keyword.

5.3.3 Favourites

Favourites are stored with the Internet radio portal, and are available through all Internet radios registered on the same account. Before favourites can be used, the radio has to be registered with the Internet radio portal.

To register your Ferguson i400s, choose Station list > Help > Get access code to get your radio's unique portal access code first. (Do not confuse the portal access code with the Radio ID from System settings).

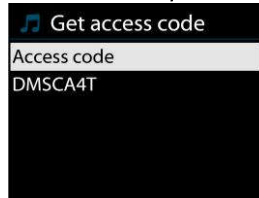

Visit the portal website at www.wifiradio-frontier.com

If this is your first visit to the portal, register for a new account, entering the following information:

- access code,
- your e-mail address,
- password,
- radio model.
-

If you already have an account and wish to add an additional radio, log in to your account and select My preferences > Add another Wi-Fi radio.

Once your radio is registered with the portal, you can immediately use the Internet radio favourites and added stations features.

To store a playing station as a favourite, press and hold the reel or **ENTER** on the remote control until the display shows 'Favourite added'. The station appears in the default favourites list Stations.

5.3.4 My added stations

Even though the Internet radio portal contains thousands of stations, you may want to listen to stations not listed. You can add your own via the portal.

5.3.5 Presets

Presets are stored in the radio and cannot be accessed from other radios.

To store an Internet radio preset, press and hold **P** until the display shows

the Save preset screen. Select one of the 10 presets to save the currently playing station.

To select a preset, press **P** , then select one of the listed preset stations.

When a preset station is playing, it shows **★ n** (**★ 1**, **★ 2** etc) at the bottom of the screen.

1 to **10/0** on the remote control are for the use of preset station 1-10.

5.3.6 Now playing information

While the stream is playing, the screen shows its name and description. To view further information, press **MENU / INFO** .

Each time you press **MENU / INFO** , another set of information is displayed, cycle through name/description, genre/location, reliability, codec/sampling rate, playback buffer and today's date.

5.4 Spotify Connect

Using This Device With Spotify Connect

A better way to listen at home

Spotify Connect lets you play Spotify through your home speakers or TV, using the Spotify app as remote.

You'll need Spotify Premium to use Connect – see details overleaf.

Step 1. Add your speakers to your wifi network (see product user instructions for details).

Step 2. Fire up the Spotify app on your phone, tablet or PC using the same wifi network as above.

Step 3. Play a song on Spotify and hit 'DEVICES AVAILABLE'.

Step 4. Choose your speakers and your music will start playing out loud.

For more information on how to set up and use Spotify Connect please visit www.spotify.com/connect

Licenses



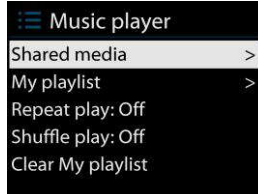

The Spotify Software is subject to third party licenses found here:
<http://www.spotify.com/connect/third-party-licenses>

5.5 Music Player

Music player mode plays audio files in MP3, WMA, WAV, AAC or FLAC format from a computer on the local network.



If you are already playing a music file, you can press **BACK** or  on the remote control rather than press and hold **MENU / INFO** to quickly return to the last visited branch of the menu tree.

You can use  or  to play the previous or next track, press and hold to rewind or fast forward. Press  to play or pause. Press  to stop playback and return to the song list.

5.5.1 Shared media

If you have set up shared media, you should see an entry consisting of *<computer name>: <Shared media name>*. If you have more than one computer sharing media, the alternatives are listed. Select the shared media you want to play.

From this point on, the menus are generated from the shared media server. The first menu shows a list of media types, for example Music, Video, Pictures and Playlists. Ferguson i400s can only play music and playlists.

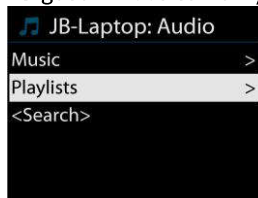

There is also a search function which finds tracks in a similar way to Internet

radio search.

From Music, there are numerous ways of selecting tracks including Genre, Artist, Album, Composer and Rating.



Once you have found a track you want to play, press the reel or **ENTER** on the remote control. A short press plays the track immediately.

5.5.2 USB playback

From this point on, menus are generated from the folders on the USB device. Browse folders with the navigate reel and **BACK** button, or direction keys on the remote control. The display shows folder and file names (not necessarily track names).

Once you have found a track you want to play, press the reel or OK (SCAN) on the remote control. A short press plays the track immediately.

The USB port is just for music playback, no charging function.

5.5.3 Repeat/shuffle

You can set to repeat tracks or play them in random order. Press SHUFFLE/REPEAT on the remote control to turn on/off the repeat function.

Press and hold SHUFFLE/REPEAT to turn on/off the random function.

5.5.4 Now playing information

While a track is playing, the screen shows its track and artist. There is also a progress bar with figures for elapsed and total track time. At the bottom of the screen, an icon indicates UPnP or USB depending on the source. To view further information, press **MENU / INFO**.

Each time you press **MENU / INFO**, another set of information is displayed, cycling through the information:

track/artist/progress bar/track times, album, codec/sampling rate,

playback buffer and today's date.

Album cover of the track from music server is supported, while album cover from USB is unsupported.

5.6 DMR (DLNA Streaming)



Shared music in Section 5.5.1 is a way of music streaming which you look for the music list and control playback from Ferguson i400s. This topic will introduce another way to do the music streaming which is not necessary to control playback on Ferguson i400s.

You can share the music files from PC, Android mobile or tablet, and directly use your PC, Android mobile, tablet or iPhone / iPad to control music playback on the Ferguson i400s. It is simple called DLNA streaming.

5.6.1 Control on PC

The PC system requirements for DLNA are **Windows 7** and **Windows Media Player 12**. Setup as below:

Firstly, share the media on your PC to Ferguson i400s.

Control Panel > Network and Internet > Network and Sharing Center > Media streaming options

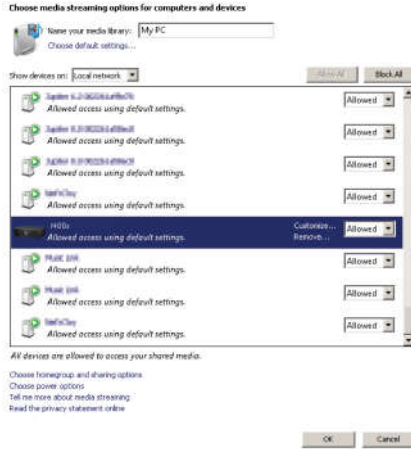

Open **Windows Media Player** to enable **Allow remote control of my Player**.



Right click any music in the library and choose Play to **Ferguson i400s** .

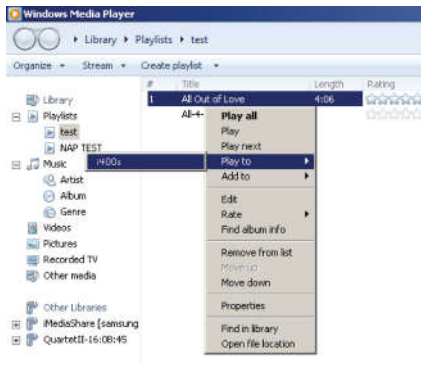

A box of music playback pops up for the streaming.

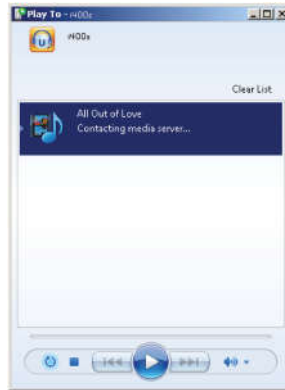

5.6.2 Control on Smartphone / Tablet

You may search and install any free or commercial DLNA Apps from **Google Play** or **Apple Store** if you are using Android mobile, tablet or iPhone / iPad.

It is suggested to use **BubbleUPnP** on Android mobile, tablet or iPhone/iPad.

Procedures for playing shared music on the app are as follows:

1. Select **Ferguson i400s** as the player.
2. Select music server and choose the music.

NOTE: Some Apps may not support streaming music from iPhone/iPod but iPhone/iPod could still be used to control streaming music from other servers.

Some Apps may allow to play the music to multi players at the same time.

Some Apps can create a playlist if you choose several music.

Study the own instruction of the software or Apps you use to enjoy DLNA streaming if necessary.

5.7 DAB

DAB mode receives DAB/DAB+ digital radio and displays information about the station, stream and track playing.

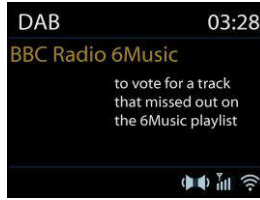

5.7.1 Scanning for stations

The first time you select DAB radio mode, or if the station list is empty, Ferguson i400s automatically performs a full scan to see what stations are available. You may also need to start a scan manually to update the list of stations for one of the following reasons:

- Available stations change from time to time.
- If reception was not good for the original scan, this may result in an empty or incomplete list of available stations.
- If you have poor reception of some stations (burbling), you may wish to list only stations with good signal strength.

To start a scan manually, choose Full scan. To scan only stations with good signal strength, select Local scan.



Once the scan is complete, the radio shows a list of available stations.



To remove stations that are listed but not available, choose Prune invalid.

Turn the navigate reel to view a list of stations and press to select. Once selected, the station plays and the screen shows information about station, track or show as broadcast.

5.7.2 Presets

To store a DAB preset, press and hold **P** until the display shows the Save preset screen. Select one of the 10 presets to save the currently playing station.

To select a preset, press **P** briefly, then select one of the listed preset

stations. When a preset station is playing, it shows  *n* (1, 2 etc) at the bottom right of the screen.

1 to **10/0** on the remote control are for the use of preset station 1-10.

5.7.3 Now playing information

While the stream is playing, the screen shows its name and DLS (Dynamic Label Segment) information broadcast by the station giving real-time information such as programme name, track title and contact details. Stereo broadcasts are indicated with an icon at the top of the screen. To view further information, press **MENU / INFO**.

Each time you press **MENU / INFO**, another set of information is displayed, cycling through DLS text, programme type, ensemble name/frequency, signal strength/error rate, bite rate/codec/channels and today's date.

5.7.4 Settings

- **Dynamic range compression (DRC)**

If you are listening to music with a high dynamic range in a noisy environment, you may wish to compress the audio dynamic range. This makes quiet sounds louder, and loud sounds quieter. You can change DRC as off, low or high.
- **Station order**

You can choose the order of the DAB station list to be either Alphanumeric, Ensemble or Valid.
Ensemble lists groups of stations that are broadcast together on the same ensemble. Valid lists valid stations first, alphanumerically, then off-air stations.

5.8 FM

FM radio mode receives analogue radio from the FM band and displays RDS (Radio Data System) information about the station and where broadcast.

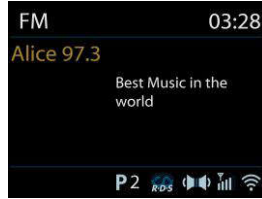

To find a station, press the reel or OK (SCAN) on the remote control. The frequency display starts to run up as Ferguson i400s scans the FM band. Alternatively, you can scan up or down by pressing and holding the buttons ◀ or ▶ or tune manually with quick presses, or by turning the reel.

5.8.1 Preset

To store a FM preset, press and hold **P** until the display shows the Save preset screen. Select one of the 10 presets to save the currently playing station.

To select a preset, press **P** briefly, then select one of the listed preset stations. When a preset station is playing, it shows ★*n* (★1, ★2 etc) at the bottom right of the screen.

1 to **10/0** on the remote control are for the use of preset station 1-10.

5.8.2 Now playing information

While the stream is playing, the screen shows its frequency, or if RDS information is available, station name and any further RDS information such as programme name, track title and contact details. If no information is available, just the frequency is shown. Stereo broadcasts are indicated with an icon at the top of the screen, To view further information about the broadcast, press **MENU / INFO**.

Each time you press **MENU / INFO**, another set of information is displayed, cycling through RDS text, further RDS text (station/programme type), frequency and today's date.

5.8.3 Settings

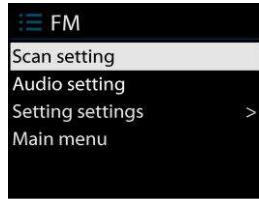

- **Scan settings**
By default, FM scans stop at any available station. This may result in a poor signal-to-noise ratio (hiss) from weak stations. To change the scan settings to stop only at stations with good signal strength, select Yes after choosing Strong station only?
- **Audio settings**
All stereo stations are reproduced in stereo. For weak stations, this may result in a poor signal-to-noise ratio (hiss). To play weak stations in mono, select FM weak reception: Listen in mono only and then YES.

5.9 Bluetooth



In Bluetooth mode, Ferguson i400s enters the pairing mode automatically. You can turn on the Bluetooth of your Bluetooth device and search the radio Ferguson i400s to pairing. When Ferguson i400s is waiting for pairing, there is a blinking Bluetooth icon at the bottom. If the pairing is successful, it has a “beep” sound and the Bluetooth icon becomes steady.

Control the music playback from your Bluetooth device.

To unpair from Ferguson i400s, press and hold **MENU / INFO** and choose BT disconnect or press and hold **P** to unpair Bluetooth.

5.10 CD



Ferguson i400s can playback CD-DA format audio CD-R/CD-RW discs that have been finalised* upon completion of recording. It may fail to play some CD-R/CD-RW discs

due to poor recording and wide variation in quality of the CD-R/CD-RW disc.

*Finalising enables a CD-R/CD-RW disc to playback on audio players. A disc which has not been finalised may have information added to it using a computer but may not always be playable.

Insert a disc with printed side facing up into the CD slot. The disc will be loaded automatically. The unit will check the CD type and load its track list. The display will show 'Loading' and then 'Reading' as the information is read.

5.10.1 Playback

Use  or  to play the previous or next track, press and hold to rewind or fast forward.

Press  to pause the track. Press it again to resume.

Press  to stop the track.

To take out the CD, press .

You can press the number key to go to the selected track.



5.10.2 Repeat/shuffle

Press SHUFFLE/REPEAT on the remote control to swap among normal playback, repeat one, repeat all (and repeat folder for MP3 / WMA CD). Press and hold SHUFFLE/REPEAT to turn on/off the function of random.

5.10.3 CD track programming

Stop the playback first if any track is playing.

Press **P** to program.

Set the first programming track, use  or  to seek the track. Press the reel or OK (SCAN) to confirm and set the next programming track.

Repeat the steps. When programming is completed, press **P**.

Press  to start playing the programmed track(s).

5.10.4 MP3 / WMA CD

Ferguson i400s is able to play CD-R and CD-RW discs containing MP3 and WMA files. It is assumed in this section that a file is equivalent to a CD track.

Playback controls are the same as 5.10.1 to 5.10.4. In addition, Ferguson i400s allows to skip folder by pressing **FOLDER UP** or **FOLDER DOWN**

on the remote control. The first file of the next or previous folder will be played.

An MP3 / WMA CD may not contain more than 512 files and not more than 99 folders. MP3 and WMA files should be created with an audio sample rate of 44.1kHz (this is normal for files created from CD audio content).

MP3 and WMA data rates up to 320 kilobits per second are supported. WMA Lossless files are not supported. The unit will not play files which include digital rights management (DRM) protection.

When burning CD-R and CD-RW discs with audio files, various problems may arise which could lead to problems with playback. Typically such problems are caused by poor CD writing or audio encoding software, or by the hardware settings of the PC's CD writer, or by the CD being used. Should such problems arise, contact the customer services of your CD writer or software manufacturer or look in their product documentation for relevant information. When you are making audio CDs, take care to observe all legal guidelines and ensure that the copyright of third parties is not infringed.

5.11 AUX IN

Aux in mode plays audio from an external source such as an MP3 player.

To play audio with Aux in mode:

- Turn the volume low on both Ferguson i400s and, if adjustable, the audio source device.
- Connect the external audio source to the Aux in 3.5mm stereo socket.
- Press  /MODE or **MODE** on the remote control, then move to AUX and press the reel or OK (SCAN) on the remote control
- Adjust the volume of Ferguson i400s (and, if necessary, the audio source device) as required.

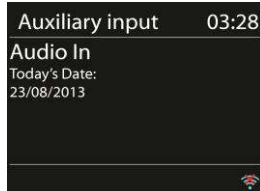

5.12 Sleep

To set the sleep timer, select Sleep under Main menu. Choose from Sleep OFF, 15 MINS, 30 MINS, 45 MINS or 60 MINS.

Once you select a sleep period, the system returns to the main menu. Press and hold **MENU / INFO** to return to the Now playing screen.

5.13 Alarm

There are two versatile wake-up alarms with snooze facility, and a sleep function to turn the system off after a set period. Each alarm can be set to start in a particular mode.

Select Alarms under Main menu to set or change an alarm.



Select the alarm number (1 or 2) then configure the following parameters:



- Enable: on/off,
- Frequency: Daily, Once, Weekends or Weekdays,
- Time,
- Mode: Buzzer, Internet Radio, Spotify, DAB or FM,
- Preset: Last listened 1-10, Preset
- Volume: 0-20

To activate the new settings, scroll down and select Save.

The screen shows active alarms with an icon at the bottom left.

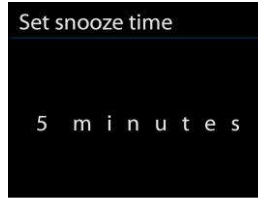
At the set time, the alarm will sound. To temporarily silence, press any key on the unit or key on the remote control excepted **⏻ /MODE** or **⏻** . You can change the snooze period. The radio returns to standby for the set period, with the silenced alarm icon flashing.



Press and hold  /MODE or press  on the remote control to turn off the alarm.

5.14 Extra Features

5.14.1 Headphone jack

Ferguson i400s featured with headphone jack for you to continue enjoying the music in vary environments, such as noisy background, or the area that requires every one keeping silent.

It is recommended to reduce the volume before put on the headphones. After the headphones are positioned properly, increase the volume to the desired level.

5.14.2 NetRemote (UNDOK)

The device gives a feature of NetRemote by smartphone or tablet in iOS or Android system. By downloading the assigned app named UNDOK, you can view all the modes of Internet Radio, Spotify Connect, Music Player, DAB, FM and AUX IN.

Search UNDOK from **Google Play** or **Apple Store**, and install it to your smartphone or tablet.



QR code for download app:

Google play:



App Store (iTunes):



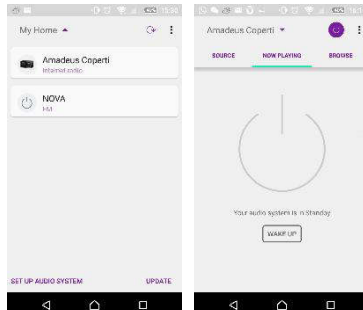

Before using the UNDOK app, make sure the device and the smartphone / tablet are in the same WiFi network.

Launch the app. The app initializes and scans for Internet Radio in the network. Tap Internet Radio to make the connection of NetRemote.



Once the smartphone / tablet has accessed to the device, they will be automatically connected next time when you open the app again. Select your desired mode in the main page. You may then control the selected mode on your smartphone / tablet and on the display of the device simultaneously.

Tap  to go to the standby mode. Tap again  or “wake up” to go to operation mode.



Tap "Browse" to view the details. Tap  to view the saved preset stations, and tap (+) to add the playing station to the desired preset station number.

- Internet Radio

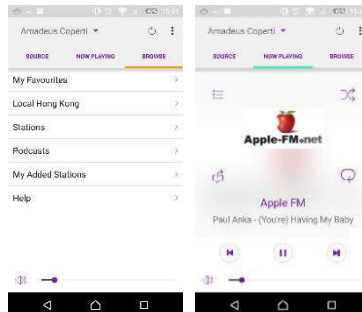

Browse the station list, choose station and view the station rolling text from the app.

- Spotify Connect (Refer to section 5.4)

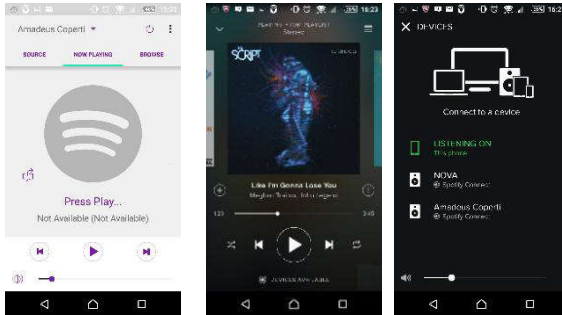

Go to Spotify app to choose the music from your Spotify playlist.

Tap the Spotify icon on the Spotify app, then choose the preferred device (Ferguson i400s). It should be displayed in the Spotify app. Once selected, music will be streaming to the device.

- Music Player

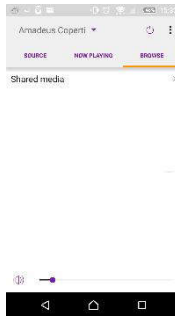

Browse the music files from shared media, choose music from the app.

- DAB

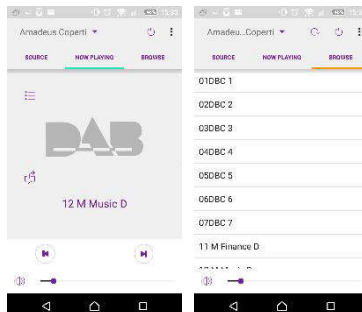

Browse the scanned DAB+ stations, choose the station and view the

rolling text of station from the app.

- FM



Manual search or scan the stations from the app.

From the app, you can also control to operate **STANDBY/ON**, **EQUALIZER**, **CHANGE PIN** and **RENAME** of the device under **SETTING** menu
For **CHANGE PIN** setting, please also refer to Section 5.2.3.

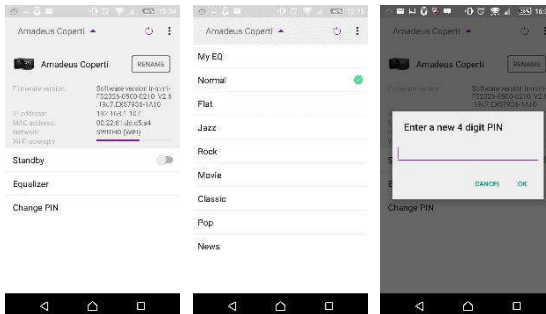

RadioVIS is a channel for broadcasters to deliver Slideshows over the Internet. RadioVIS Slideshows appear like the DAB+ slideshows, they are closely associated with the broadcasted audio service. However it is only available in some countries around the world. (Visit radioDNS.org for more details about their broadcasts.)

Once RadioVIS is enabled in the app, and the slideshows are available, the slideshows will be shown from Now Playing display in the DAB mode or FM mode on the NetRemote app.

NOTE: Be aware that if another smartphone / tablet with the app in the same network have access with the device, the original connection will be cut off.

6. Troubleshooting

Error	Remedy
The device does not switch on.	Check if the power adaptor is connected properly.
No sound.	<ol style="list-style-type: none"> 1. Turn on the sound as it may be muted 2. Increase the volume. 3. Pull any connected headphone or speaker from the connector jack.
No network connection can be established.	<ol style="list-style-type: none"> 1. Check the LAN cable or the WLAN function. 2. Try to set an IP address at the device. 3. Activate the DHCP function on the router and make the connection again at the device. 4. A firewall is activated on the network – set the respective program in such a way that access is possible. 5. Reboot the router
WiFi connection cannot be established.	<ol style="list-style-type: none"> 1. Check the availability of WLAN network on the router. 2. Place the device closer to the router. 3. Make sure the password is correct.
Wired connection cannot be established.	<ol style="list-style-type: none"> 1. Check the availability of LAN network on the access point. 2. Reconnect or even replace the LAN cable.
No station is found.	<ol style="list-style-type: none"> 1. Check the network as well as the access point and firewall. 2. The station may not be available currently, try it again later or select another station. 3. The link of the station is changed or the station no longer transmits – ask the provider for information. 4. The link of manual added station is not correct, make sure it is correct and re-enter.
Hiss in FM mode	<ol style="list-style-type: none"> 1. Check/move the FM antenna. 2. Move the radio.
No stations available / burbling / intermittent in DAB mode.	<ol style="list-style-type: none"> 1. Move the radio. 2. Rescan local stations only (high-strength).

	3. Check the local DAB coverage.
Alarm does not work.	<ol style="list-style-type: none"> 1. Switch on the alarm. 2. Due to the volume setting, refer to the solutions of “No sound”. 3. The source of alarm was set to be station but there is no network connection. Change the source of alarm or reconfigure the connection.
USB driver or MP3 player is not detected.	<ol style="list-style-type: none"> 1. Check if the USB driver or MP3 player is plugged properly. 2. Some USB hard disks need external power supply, make sure it is connected to the power. 3. Not all MP3 players can be read directly on the device – use an USB drive instead.
All other undetermined cases.	Ferguson i400s may process large amount of data after a period of operation, no matter in which mode, it will cause the system freeze or malfunction. Reboot Ferguson i400s if necessary.
	The normal function of the product may be disturbed by strong Electro-Magnetic Interference. If so, simply reset the product to resume normal operation by following the instruction manual. In case the function could not resume, please use the product in other location.
	The device may malfunction when used in areas with strong radio interference. The device will work properly again once there is no more interference.

7. Specification

Model number	Ferguson i400s
Description	Internet Radio with FM/DAB+/BT/CD player/Spotify/Undok
Display	2.8", 320 x 240, TFT colour display
Network supported	IEEE 802.11b/g/n wireless (WiFi) Bluetooth (BT 4.0, Supports A2DP, AVRCP profiles)

Encrypted key	WEP, WPA, WPA2 (PSK), WPS
Streaming	UPnP, DLNA
Supported playback formats (streaming, USB)	MP3 (up to 320 kbit/s), WMA (up to 384 kbit/s), WAV (up to 1.536 mbit/s), AAC/AAC+ (up to 96kHz, 24bit), FLAC (up to 48kHz, 24bit)
CD player	Supports CD-ROM, CD-R, CD-RW
Supported playback formats (CD)	CD-DA, MP3, WMA (up to 48kHz, 384kbps)
DAB / DAB+	Band III (174.928 – 239.200 MHz)
FM	87.5 – 108.0 MHz, support RDS
Power Supply	Power Adaptor, 16V 2250mA
Remote Control Power Supply	2 x 1.5V AAA battery
Standby mode power consumption	<1W
Networked standby mode power consumption	<6W
Operating temperature	0 °C - 35 °C
Speaker power output	2 x 15W RMS
Connections	3.5mm headphone socket USB port (for playback only, no charging function) 3.5mm aux in socket, stereo DC IN power supply socket
Dimensions	350 mm(L) x 105 mm(H) x 250 mm(D)
Weight	3.55 kg

Specifications subject to change without notice.

Manufacturer	Shenzhen All-Key Technology Co. Ltd.
Type	AKN7G-1600225V
Input	100 – 240V AC, 50/60 Hz
Output	16V 2250mA 
Safety Class	II

Use only original AC adaptor

Use only the power supply listed in the user instructions

Specifications subject to change without notice.

