

4-key ZigBee Wall Dimmer FS2WDM



Important: Read All Instructions Prior to Installation

Function Introduction

With 4-key front plate

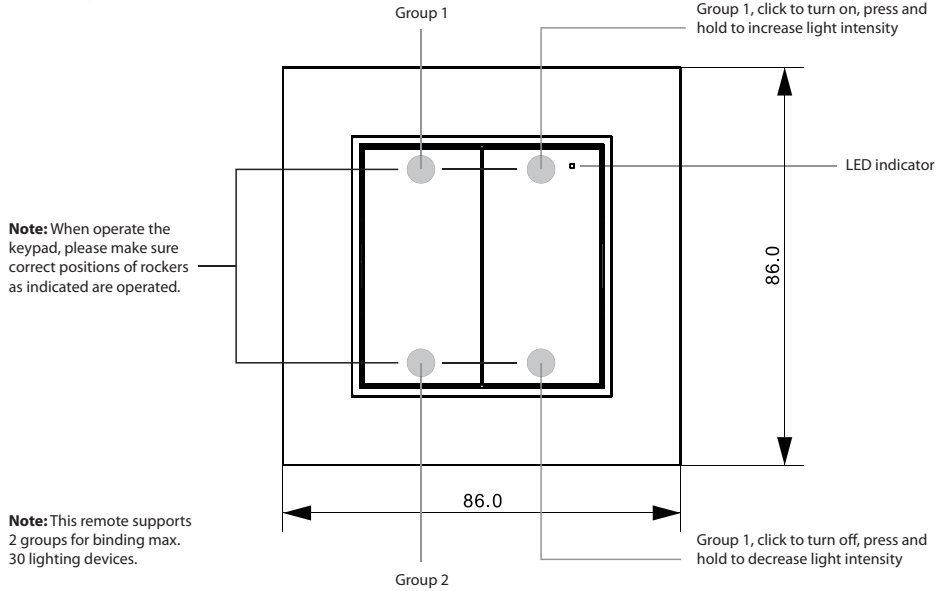

Can be replaced with 8-key front plate (front plate purchased separately as spare parts)

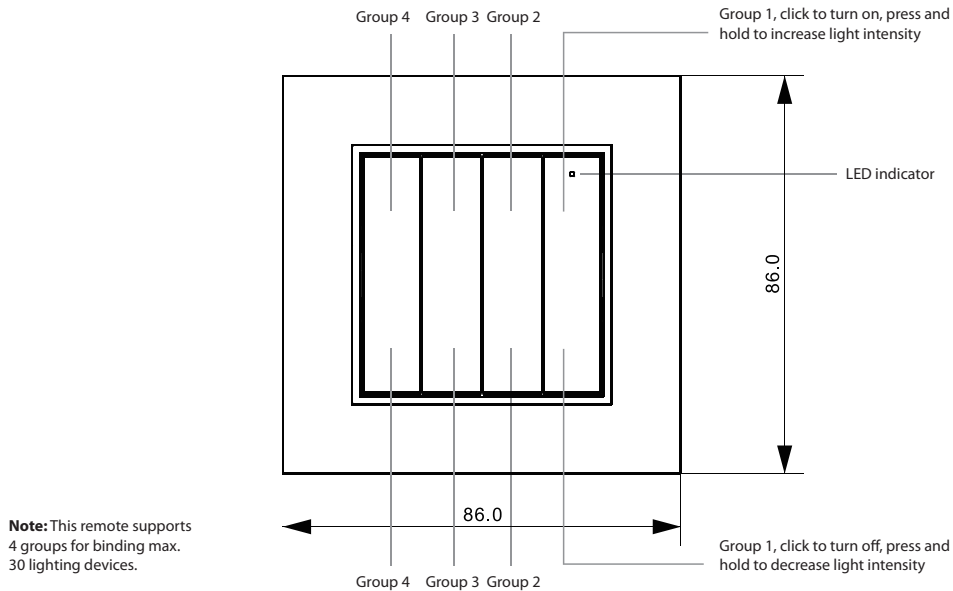

Can be replaced with 2-key front plate (front plate purchased separately as spare parts)

Group 1, click to turn on, press and hold to increase light intensity

Note: This remote supports 1 group for binding max. 30 lighting devices

Group 1, click to turn off, press and hold to decrease light intensity

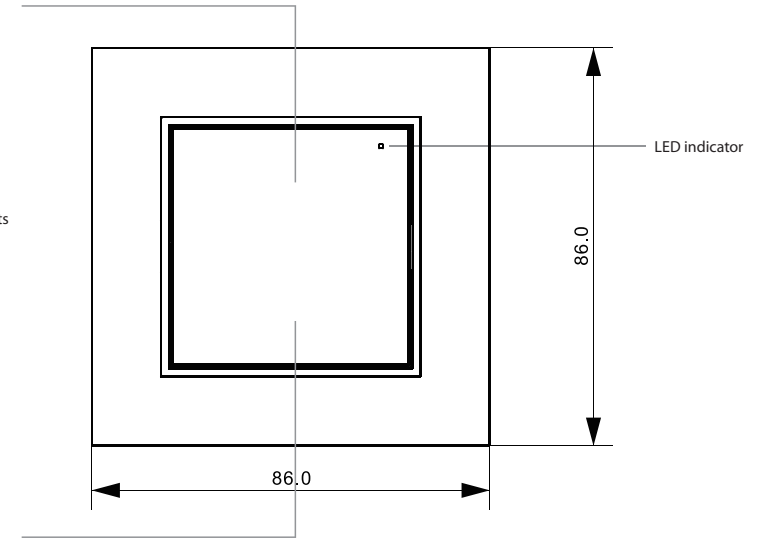

Back side

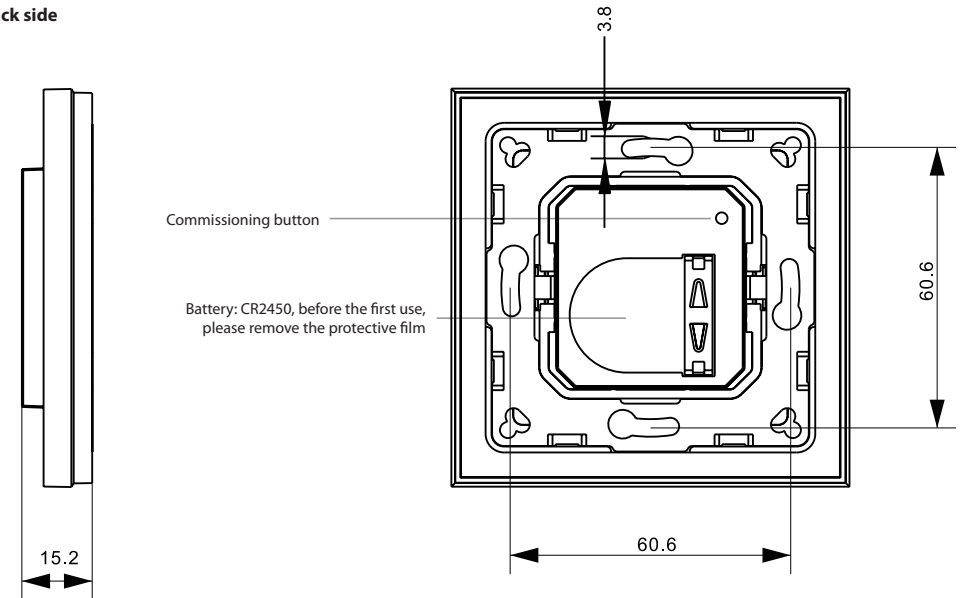

Product Features

- ZigBee dim remote based on ZigBee 3.0
- Enables to control single color lighting devices
- Battery powered remote with low power consumption
- Enables to pair ZigBee lighting devices via touchlink commissioning without coordinator
- Supports find and bind mode to pair with ZigBee lighting devices
- Supports 2 groups for binding max. 30 lighting devices

- 2.4GHz global operation
- Transmission range up to 30m
- Compatible with universal ZigBee Gateway products
- Compatible with universal single color ZigBee lighting devices
- Front plate can be replaced with 8-key or 2-key front plate

Product Data

Operation Frequency	2.4GHz
Transmission Range (free field)	30m
Power Supply	3VDC (CR2450)
Operating Temperature	0-40°C
Relative Humidity	8% do 80%
Dimming Range	0.1%-100%
Dimensions	86.0x86.0x15.2mm
Protection Type	IP20

ZigBee Clusters Supported by This Remote Are As Follows:

Input clusters:

- Basic
- Power Configuration
- Identify
- Diagnostics

Output clusters:

- Identify
- Group
- On/off
- Level control
- Ota

Safety & Warnings

- This device contains a button lithium battery that shall be stored and disposed properly.
- Do not expose the device to moisture.
- Do not ingest battery, Chemical Burn Hazard
- This product contains a coin / button cell battery. If the coin / button cell battery is swallowed, it can cause severe internal burns in just 2 hours and can lead to death
- Keep new and used batteries away from children.
- If the battery compartment does not close securely, stop using the product and keep it away from children.
- If you think batteries might have been swallowed or placed inside any part of the body, seek immediate medical attention

Operation

1. This ZigBee Dim remote is a wireless transmitter that communicates with a variety of ZigBee compatible systems. This transmitter sends wireless radio signals that are used to remotely control a compatible system.
2. This ZigBee remote supports 2 groups for binding max. 30 lighting devices and enables to control single color ZigBee lighting devices.

3. Zigbee Network Pairing through Coordinator or Hub (Added to a Zigbee Network)

Step 1: Remove the remote from previous zigbee network if it has already been added to it, otherwise pairing will fail. Please refer to the part „Factory Reset Manually“.

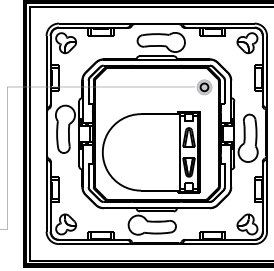

Step 3: Short press the commissioning button 5 times.

Step 2: From your zigbee controller or hub interface, choose to add device or accessory and enter Pairing mode as instructed by the controller.

Step 4: LED indicator flashes every 1 second, 20 seconds timeout if there is no network. Indicator will then blink 5 times quickly for successful pairing.

Note:

1. After pairing successfully, the remote information will appear on the controller or hub interface.
2. No remote information will appear on the hub interface if pairing to some Zigbee hubs.

4. TouchLink to a Zigbee Lighting Device

Step 1: Set the zigbee lighting device to start TouchLink commissioning, please refer to its manual to learn how.

LED indicator

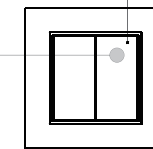

Step 2: Bring the remote within 10cm of the lighting device.



Step 3: Short press ON button of group 1/2 to choose a group that you would like to pair the device to.

Step 4: Short press commissioning button 2 times to start TouchLink commissioning of the remote.

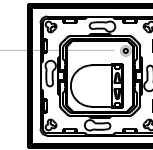

Step 5: LED indicator flashes fast for 3S, then flash 6 times slowly to indicate successful pairing to the device and the light connected to the device will blink twice.

Note:

1. Directly TouchLink (both not added to a ZigBee network), please first factory reset both the remote and device, each remote can link with max. 30 devices, please make sure the first linked device is always powered on when touchlink the remote with 2nd device and more devices.
2. TouchLink after both added to a ZigBee network, each device can link with max. 30 remotes.
3. To control by both remote and hub, add both remote and device to network first then TouchLink, after TouchLink, the device can be controlled by the linked remotes and Zigbee hub together.

5. Removed from a Zigbee Network through Coordinator or Hub Interface

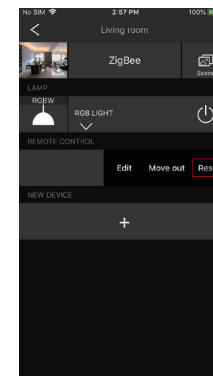

From your ZigBee controller or hub interface, choose to delete or reset the remote as instructed, indicator flashes 3 times quickly to indicate successful removing.

6. Factory Reset Manually

Step 1: Short press commissioning button 5 times continuously, indicator flashes 3 times quickly to indicate successful reset.

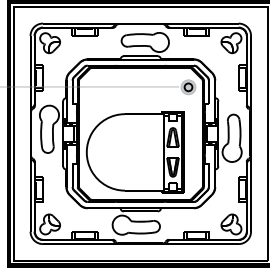

Note: All configuration parameters will be reset after the remote is reset or removed from the network.

7. Remove a Touchlink Paired ZigBee Lighting Device

Step 1: Set the Touchlink paired zigbee device to start TouchLink commissioning, please refer to its manual to learn how.

Step 3: Short press ON button of group 1/2 to choose the group that the device was touchlink paired to.

Step 4: Press and hold down commissioning button over 3S until LED indicator turns on.

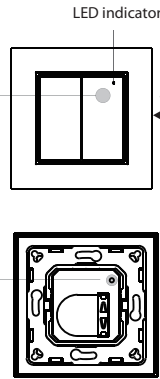

Step 2: Bring the remote within 10cm of the lighting device.

Step 5: Immediately short press ON button of group 1 two times to start TouchLink removing of the remote. LED indicator flashes fast for 3s, then flash 6 times slowly to indicate successful removing.

8. Factory Reset a Lighting Device (Touch Reset)

Note: the device shall be added to a network, the remote added to the same one or not added to any network.

Step 1: Set the zigbee device to start TouchLink commissioning, refer to its manual.

Step 3: Press and hold down commissioning button over 3s until LED indicator turns on.

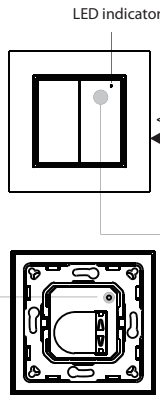

Step 2: Bring the remote within 10cm of the lighting device.

Step 4: Immediately short press ON button of group 1 five times to start Touch Reset of the remote. LED indicator flashes fast for 3S, then flash 3 times slowly to indicate successful reset.

9. Find and Bind a Zigbee Lighting Device

Note: Make sure the device and remote already added to the same zigbee network.

Step 1: Start find and bind mode on the Zigbee lighting device (initiator node) and enable it to find and bind target, refer to its manual.

Step 2: Short press ON button of group 1/2 to choose a group that you would like to bind the device to.

Step 3: Press and hold down commissioning button over 3S until LED indicator turns on.

10. Find and Unbind a Zigbee Lighting Device

Step 1: Start find and bind mode on the ZigBee lighting device (initiator node) and enable it to find and bind target, refer to its manual.

Step 2: Short press ON button of group 1/2 to choose the group that the device already bound to.

Step 3: Press and hold down commissioning button over 3S until LED indicator turns on.

11. Clear All Find and Bind Mode Paired Lighting Devices

Step 1: Short press ON button of group 1/2 to choose the group that you would like to unbind all devices.

Step 2: Press and hold down commissioning button over 3S until LED indicator turns on.

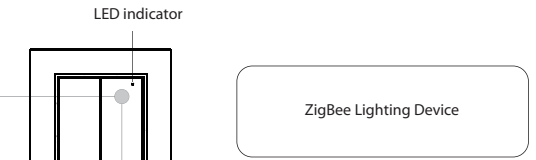

Step 4: Short press ON button of group 1 to enable the remote (target node) to find and bind initiator. LED indicator flashes 4 times for successful binding or twice if binding fails.

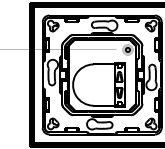

Note: Each remote can bind max. 30 lighting devices.

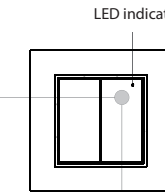

Step 4: Short press ON button of group 1 two times to enable the remote (target node) to find and unbind initiator. LED indicator flashes 4 times for successful unbinding or twice if unbinding

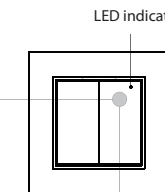
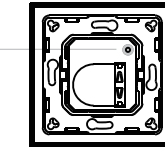

Step 3: Short press ON button of group 1 five times continuously to clear all bound lighting devices LED indicator flashes 4 times for successful unbinding.

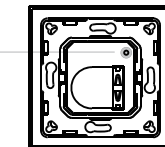

12. Setup a Network & Add Devices to the Network (No Coordinator or Hub Required)

Step 1: Factory reset the remote and the lighting device, refer to their manuals.

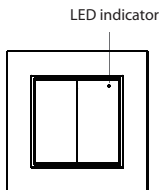

LED indicator

Step 2: TouchLink the remote and device to setup a network, refer to their manuals.

Step 4: Set another remote into network pairing mode and pair it to the network, refer to its manual.

Step 5: Add more remotes to the network as you would like.

Step 6: Factory reset the lighting devices that you would like then add them to the network, refer to their manuals.

Step 7: Touchlink to pair the added remotes and lighting devices, refer to their manuals. Each remote can link with max. 30 lighting devices. Each lighting device can be linked by max. 30 remotes.

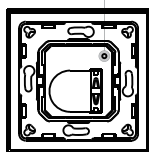

< 10cm

ZigBee Lighting Device

Step 3: Short press commissioning button four times to enable the network to discover and add devices, LED indicator will flash twice. 180 seconds timeout, repeat the operation.

13. OTA

The remote supports firmware updating through OTA, and will acquire new firmware from zigbee controller or hub every 120 minutes automatically.

14. How to Check Whether the Remote Belongs to a Network or not

Short press any button, indicator blinking means the remote has already been added to a network, no blinking of indicator means the remote does not belong to any network.

15. Battery Power Monitor Function

The remote will report battery power value to the coordinator under following situations:

- When powered on.
- When operating the switch to send data packets (over 4 hours since last operation).
- When added to the network by a coordinator.



CAUTION

Risk of explosion if the battery is replaced by an incorrect type

- replacement of a battery with an incorrect type that can defeat a safeguard (for example, in the case of some lithium battery types);
- disposal of a battery into fire or a hot oven, or mechanically crushing or cutting of a battery, that can result in an explosion;
- leaving a battery in an extremely high temperature surrounding environment that can result in an explosion or the leakage of flammable liquid or gas;
- a battery subjected to extremely low air pressure that may result in an explosion or the leakage of flammable liquid or gas.

Installation

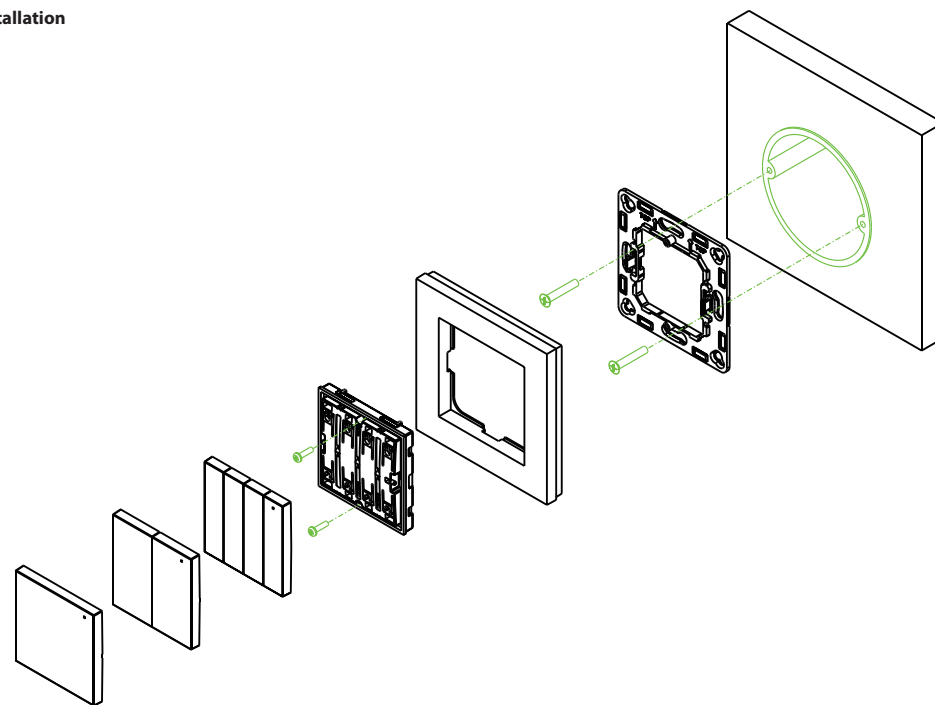

Note: It is easy to remove the switch rocker covers tool-lessly with your finger as follows. Just pull out from one side slightly, then pull out the other side.

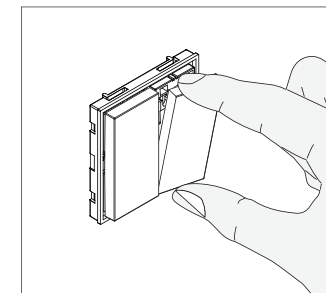
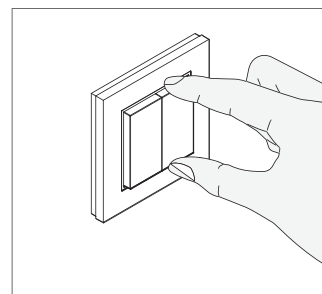

Mounting

The key part of this controller is an universal one, especially rotary standard switch element that can be integrated in numerous frames by different manufactures as below list:

BERKER	S1, B1, B3, B7 glass
GIRA	Standard55, E2, Event, Esprit
JUNG	A500, Aplus
MERTEN	M-Smart, M-Arc, M-Plan

Battery Warnings & Safty

Warnings and Statements:

This product contains a CR Coin Cell Lithium Battery and meets the requirements of the 16 CFR Part 1263. For your safety and to ensure proper operation, please carefully read and understand the following warning sand statements.

⚠ WARNING

- **INGESTION HAZARD:** This product contains a button cell or coin battery.
- **DEATH** or serious injury can occur if ingested.
- A swallowed button cell or coin battery can cause **Internal Chemical Burns** in as little as 2 hours.
- **KEEP** new and used batteries **OUT OF REACH of CHILDREN**
- Seek immediate medical attention if a battery is suspected to be swallowed or inserted inside any part of the body.



Statements:

- INDOOR USE ONLY
- Remove and immediately recycle or dispose of used batteries according to local regulations and keep away from children.
- Do NOT dispose of batteries in household trash or incinerate.
- Even used batteries may cause severe injury or death.
- Call a local poison control center for treatment information.
- Do not install any battery other than CR2450 or its equivalent.
- Ensure the CR2450 operates at the nominal battery voltage (3VDC).
- Non-rechargeable batteries are not to be recharged.
- Do not force discharge, recharge, disassemble, heat above (manufacturer's specified temperature rating) or incinerate. Doing so may result in injury due to venting, leakage or explosion resulting in chemical burns.
- Ensure the batteries are installed correctly according to polarity (+ and -).
- Do not mix old and new batteries, different brands or types of batteries, such as alkaline, carbon-zinc, or rechargeable batteries.
- Remove and immediately recycle or dispose of batteries from equipment not used for an extended period of time according to local regulations.
- Always completely secure the battery compartment. If the battery compartment does not close securely, stop using the product, remove the batteries, and keep them away from children.
- If the battery leaks, do not touch or smell it, wipe the leakage from the battery compartment, and then replace the battery with a new one.
- If a battery leaks and the material contacts your skin or clothing, flush the exposed area thoroughly with running water. In case of eye contact, flush thoroughly with copious amounts of clean running water and seek immediate medical assistance.

Battery information:

Battery	Battery Type	Operation Voltage	Diameter
CR2450	Button Cell	3VDC	24.5mm (0.965inch)